

# PRODUCT SPECIFICATIONS



## ONE RGBW Single Source LED Underwater Light (Dimmable)

### Product Description

The most advanced underwater light. This integrated LED version is the first underwater light of this premium series to offer powerful, vivid RGBW color-changing capabilities. The fixture ships set at 100% light output with 2700K color temperature. Color modes and 10-step dimming options are unlocked using the RGBW Remote Control (only one remote control is required to control RGBW lights). Offers interchangeable optics - 60° lens pre-installed and 38° lens available separately. Constructed of durable cold forged brass with a robust base for secure mounting - no hardware required. Shielded and grated glare guard options available separately. Backed by a Lifetime Warranty.

### Product Dimensions

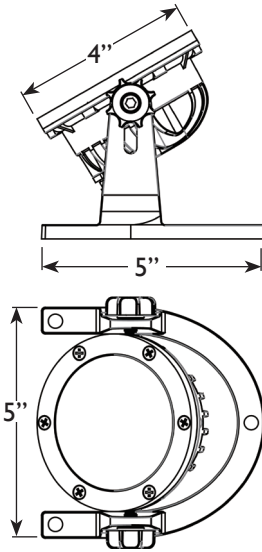

### Features & Benefits

- ▶ Cold forged brass faceplate with pressure fit gasket (must be tightened in a star pattern) to guarantee complete waterproofing.
- ▶ Water tight wire glands ensure water cannot get inside the fixture.
- ▶ Extra heavy brass mount for stability.
- ▶ This fixture can be used fully submersed in water or on land.
- ▶ Raised lens to prevent water from puddling.
- ▶ These underwater lights have 2 additional styles of faceplates to choose from: shielded & grated (sold separately).
- ▶ RGBW available with remote sold separately.
- ▶ Comes with 60° optic pre-installed (38° available separately)



### Specifications

- ▶ **Construction:** Solid Cast Brass
- ▶ **Finish:** Bronze
- ▶ **Lead Wire:** 18AWG
- ▶ **Mounting:** 9" Hammer Stake
- ▶ **Lens:** Clear flat glass
- ▶ **Torque Setting:** 1.5 ft. lbs
- ▶ **Powered by:** Low Voltage Transformer
- ▶ **CCT for White Color:** 2700K
- ▶ **Beam Angle:** 60° (38° available separately)
- ▶ **Lumens:** 650lm @ 100%
- ▶ **Power Consumption:**

• 100% - 12w	50% - 9w
• 90% - 11w	40% - 7w
• 80% - 10.5w	30% - 5w
• 70% - 10w	20% - 4w
• 60% - 9.5w	10% - 2w

### Warranty

Lifetime Warranty

### Certifications



LISTED File #E466348



LISTED File #E466348

# INSTALLATION & MAINTENANCE GUIDE



## Low Voltage UnderWater Lighting

ONE RGBW Single Source LED Underwater Light (Dimmable)





**! Important: Please Read Before Installation**

This luminaire is intended for installation in accordance with local codes and the National Electric Code (NEC). Failure to adhere to these codes and instructions may result in serious injury, property damage and void the warranty.

These instructions do not intend to cover all variations in installation, operation maintenance or mounting situations.

1. Make sure that the power is turned OFF before installing or servicing this luminaire.
2. **WARNING:** risk of electrical shock. Install all luminaires 10 feet (3.05M) or more from pool, spa or fountain.
3. This luminaire is intended to be used only with a power supply (transformer) rated maximum of 300 watts (25 AMPS) at 15 volts.
4. Wiring connections must be made with UL listed wire connectors that are suitable for outdoor use.
5. Position the low voltage wire and wire connector so that it is located within 6 inches (15.2 cm) from a building structure, a luminaire or fitting.
6. The main low voltage cable is intended for shallow burial - less than 6 inches (152 mm).
7. **“WARNING - RISK OF ELECTRIC SHOCK”**
  - Use only in ponds and small decorative fountains where persons will immerse no more than their hands and lower arms while the product is energized.
  - **DO NOT** use in water intended for swimming, wading, immersion, or bathing.
  - All installer completed cable connections must be located outside of pond or fountain.
  - Low voltage circuit must be supplied by a power unit marked as suitable for supplying submersible luminaires.
  - Power unit must be supplied by a circuit protected by a ground fault circuit interrupter (GFCI).
  - **“Maximum depth: 18 in (450 mm)”**.

## ! Important Safety Instructions

### INSTRUCTIONS PERTAINING TO A RISK OF FIRE, OR INJURY TO PERSONS

#### Lighted lamp is HOT!

WARNING - TO REDUCE THE RISK OF FIRE OR INJURY TO PERSONS.

1. Turn off/unplug and allow to cool before replacing lamp.
2. Lamp gets HOT quickly! Contact only switch/plug when turning on.
3. Do not touch the hot lens, guard or enclosure.
4. Keep lamp away from materials that may burn.
5. Do not touch lamp at any time. Use a soft cloth. Oil from skin may damage lamp.
6. Do not operate the luminaire fitting with a missing or damaged shield.

## Package Contents

- A. (1) Fixture body

## Parts Required (sold separately)

- A. (3) Mounting Screws  
B. (3) Flat Washers  
C. (3) Anchors

## Product Dimensions

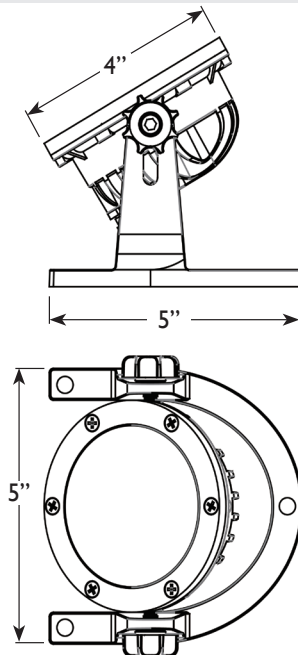

## 1 Install Horseshoe Mount

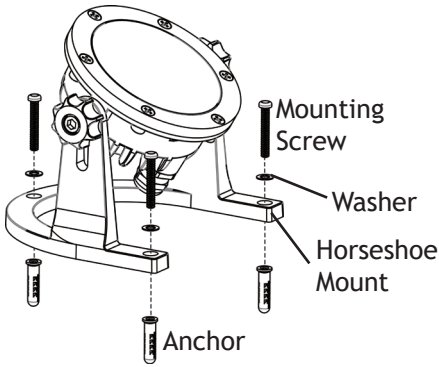

Place the horseshoe mount on the desired location and mark (3) points for the anchors from the holes on the horseshoe mount.

Drill proper holes on the location and insert anchors into the drilled holes. Attach the horseshoe mount onto the anchors. Pass the washers over the mounting screws and thread the mounting screws into the anchors to secure the horseshoe mount. Hand tighten until snug with a screwdriver.

**NOTE: SOME APPLICATIONS ARE NOT SUITABLE FOR PERMANENT MOUNTING AND DO NOT REQUIRE OR WARRANT THE USE OF SCREWS AND ANCHORS**

## 2 Wire Connection

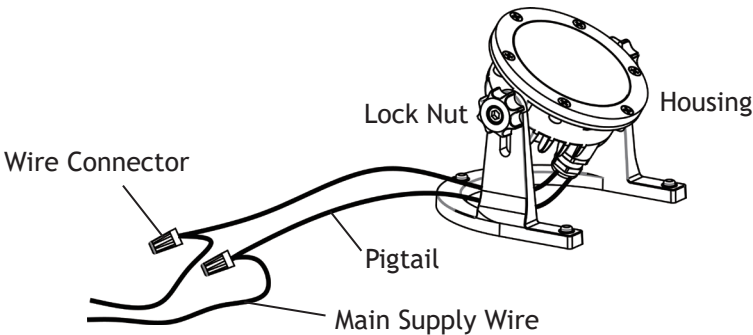

Strip both leads from the luminaire pigtail. Using wire connectors (sold separately), connect the leads from the luminaire to the main supply cable leads.

Adjust the housing to your desired direction by using the lock nuts on the side of the housing.

## IR Remote (Optional)

An IR Remote is optional for this fixture. The IR remote requires two AAA batteries.

### 1 Remove the Battery Compartment Cover

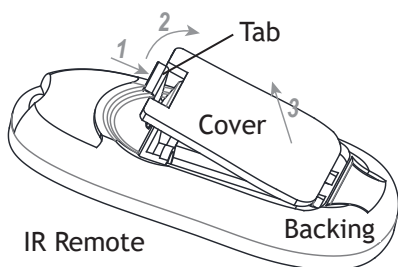

Press the tab and rotate the battery compartment cover to remove it from the IR Remote.

## 2 Install Two AAA Batteries

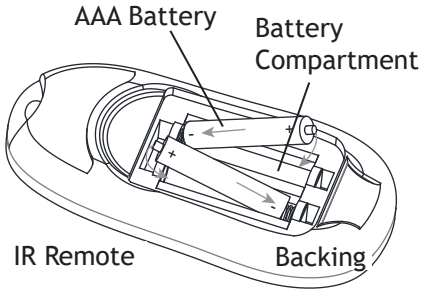

Place two AAA batteries into the battery compartment properly.

## 3 Install the Battery Compartment Cover

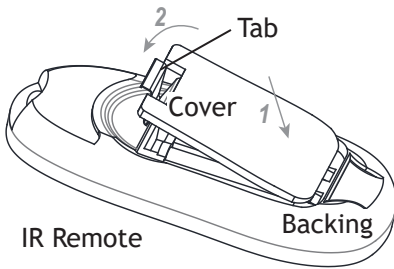

Place the battery compartment cover back onto the IR Remote.

## 4 IR Remote Functions

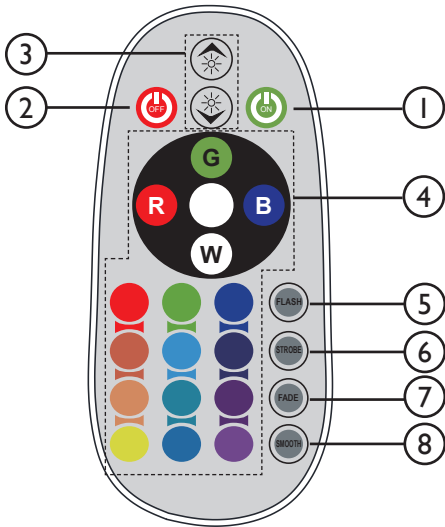

1. On
2. Off
3. Brightness Control
4. 16 color selections
5. Flash
  - A. Mode 1: Repeats Red, Green, Blue + color cycle for 1 second duration of each of the seven colors within this mode.
  - A. Mode 2: Hit flash a second time and this mode slowly blends the same seven colors from mode one, mixing them together.

### 6. Strobe

- A. Mode 1: Pick any color on the remote, then press strobe and that color will strobe every second alternating between on and off.
- A. Mode 2: Hit strobe a second time and this mode will strobe a blended white color at the same speed as before.

### 7. Fade

- A. Mode 1: Pick any color on the remote, then press fade and that color will slowly fade on and off every second.
- A. Mode 2: Hit fade a second time and it will fade a blended white color on and off at the same speed as before.

### 8. Smooth

- A. Mode 1: Repeats a flash cycle of Red, Green, and Blue only.
- A. Mode 2: Hit smooth a second time and this mode slowly blends Red, Green, and Blue only; on and off at the same speed.